

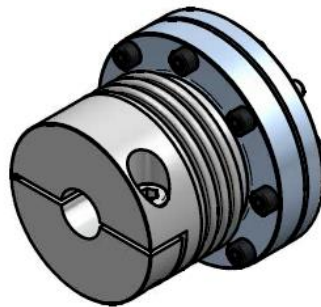

Coupling Series KB4FA

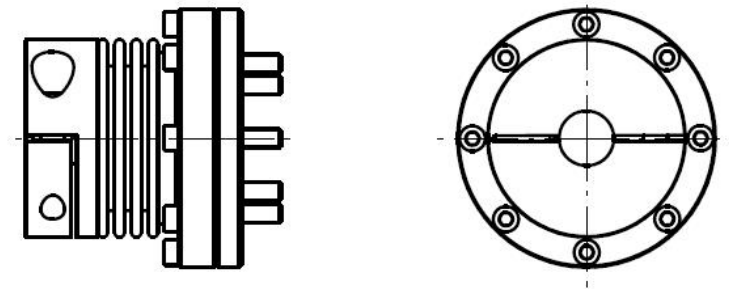

General Information

The installation and operation instructions are an essential factor of the KBK metal bellows couplings. It indicates tips for proper assembly, operation and maintenance. Please read these instructions carefully and follow the directions. Non-observance may result in failure of the KBK metal bellows coupling.

 The couplings are available in ATEX version. Please note the supplementary operating- and assembly instructions for areas with potentially explosive atmospheres.

Safety Instructions



ATTENTION!

- Installation may be performed by trained and specialized staff only.
- Rotating couplings are hazard areas. The user/operator has to ensure appropriate protective measures. Do not reach into the operation area of the coupling if it is still in operation. Secure the machine against unintentional power-up during assembly work.

Manufacturer's Declaration

In accordance with directive 2006/42/EC annex IIB, shaft couplings are no machines as per the machinery directive, but components for installations in machines. Operation is not permitted, unless the directives according to the machinery directives are complied with upon integration in the final product.

Metal bellows coupling with adapter flange: KB4FA



Function

KBK miniature metal bellows couplings are flexible shaft couplings. The metal bellow compensates lateral, axial and angular misalignment with low restoring forces.

Shaft-hub connections

KBK metal bellows couplings may only be used in accordance with the technical data mentioned in the catalogue. Any subsequent processing is not permitted.

Preparation for assembly

During assembly and disassembly, the metal bellow must not be deformed more than three times higher than the permissible misalignment values mentioned in the catalogue. Avoid using any force. The shafts and bores of the hubs to be connected must be free from dirt and burrs. Please check the connection dimensions of the shafts (as well as the dimensions regarding the key) and check the tolerances. KBK metal bellows couplings have got an H7 fit. This fitting tolerance and the shaft extension facilitate both assembly and disassembly. The recommended fitting tolerance is 0,02mm - 0,05mm.



ATTENTION!

Any oils and fats including molybdenum disulfide or any other high-pressure additives as well as lubricating pastes may not be used.

Assembly

- Slide the adapter flange onto the centering of the servo gear and tighten it in a crosswise pattern. (Tightening torque of the screws (I) according to the recommendation of the transmission manufacturer)
- In the second step connect the coupling with the adapter flange and tighten the screws (G) also in a crosswise pattern according to the tightening torque stated in the table.
- Then slide the complete metal bellows coupling with transmission onto the shaft and tighten the fastening screw (F) in correct axial position to the tightening torque stated in the table.

Please note: Step B and C can be performed in reverse order.

KB4FA /	18	30	60	150	300	500	1400
T _A (Nm) (F)	8	15	40	84	145	145	470
T _A (Nm) (G)	4,5	8	8	14	14	35	35

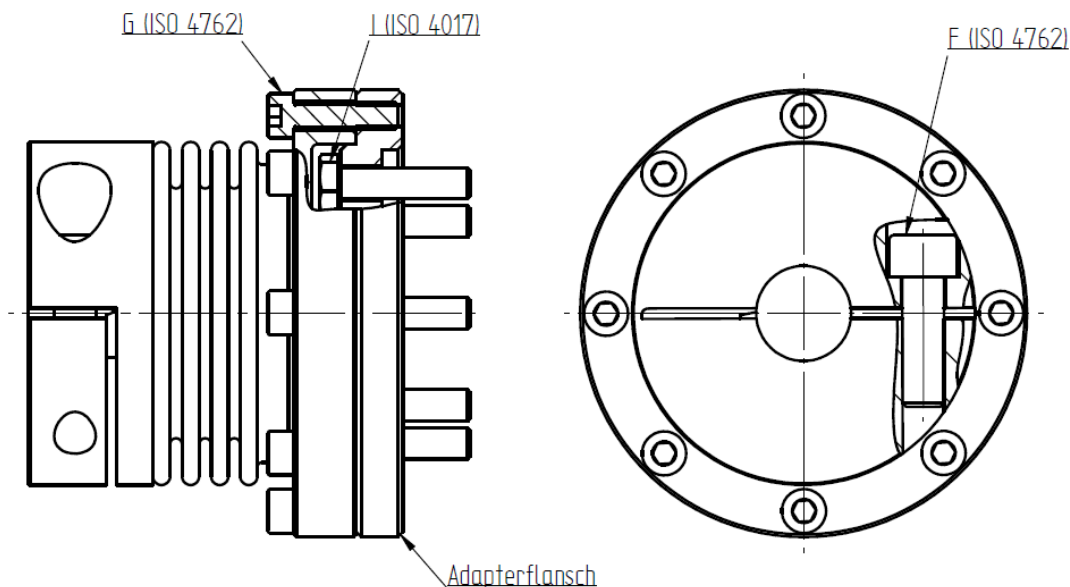

Disassembly

For disassembly of the KBK metal bellows coupling, proceed in the reverse order as for the assembly.

Maximum Misalignment

KBK metal bellows couplings compensate lateral, axial and angular shaft misalignment.

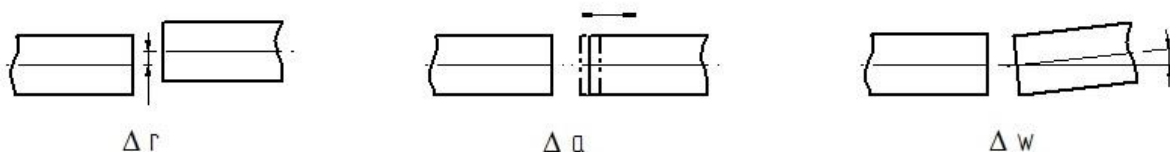

$$\sum \left[\frac{\Delta r}{\Delta r_n} * 100\% + \frac{\Delta a}{\Delta a_n} * 100\% + \frac{\Delta w}{\Delta w_n} * 100\% \right] < 100\%$$

Definition	
Δr	Radial misalignment (installed condition)
Δa	Axial misalignment (installed condition)
Δw	Angular misalignment (installed condition)
Δr_n	Maximum permissible radial misalignment (according to catalogue)
Δa_n	Maximum permissible axial misalignment (according to catalogue)
Δw_n	Maximum permissible angular misalignment (according to catalogue)

 Information!	<p>The maximum guideline value for the different misalignments can be found in our catalogue under 'technical information'. They provide security to compensate operation-related external influences e.g. thermal expansions and / or sinking foundation.</p>
--	--

 ATTENTION!	<p>Lateral misalignment has a negative effect on the service life of the metal bellow. An exact alignment of the coupling increases the service life considerably. The load for neighboring bearings is reduced and this will have a positive effect on the running smoothness of the entire driveline.</p>
--	---

Maintenance

KBK metal bellows couplings are maintenance-free. Regular inspection intervals should include a visual check of the KBK metal bellows couplings. If KBK metal bellows couplings are used as intended, they will have a long-lasting durability.

Transportation

KBK metal bellows couplings are delivered ready for installation. Upon incoming goods inspection the metal bellows couplings should be stored in their original packaging and in this way they should be made available for installation. Operating and installation instructions should be always accessible for everybody at the installation location upon installation.